

SECUFLEX[®] Pre-applied waterproofing system (FBVS)



Technical information



Table of contents

Pre-applied waterproofing systems (FBaVS)	4	Service	26
<hr/>		<hr/>	
SECUFLEX®	6	Our synergy concept for you	26
<hr/>			
Technical information	7		
<hr/>			
Installation instructions	9		
<hr/>			
Accessories	22		
<hr/>			
Additional products	24		

Technology and system

The challenge of waterproofing

Today's construction projects are more challenging than ever for everyone involved in planning and building. The complexity of the structures, constraints, environmental conditions and the most diverse demands for use and maintenance require detailed knowledge from all those involved. Seamless collaboration between planners and builders and the optimal coordination of building materials and equipment are vital to ensure high quality standards. But this also avoids any hefty subsequent costs for rework and contributes to the economic success of the project.

This type of construction project often involves high-value waterproof structures, which is why pre-applied waterproofing systems (FBVS) are being used more and more frequently in this sector. These products are applied to the surface and used as auxiliary elements in structures that are planned and executed according to the German watertight concrete guideline. They reduce the effort and cost of treating unplanned, water-bearing surface cracks to a minimum, especially in high-grade buildings. The system must be laid in advance of other work due to the mechanical bond it makes with the fresh concrete (an essential feature) and the need to access the components. Pre-applied waterproofing systems are not yet subject to regulation either in the German watertight concrete guideline or elsewhere, so their use must be contractually agreed upon with the client in advance.

Area of application for an FBVS

The main field of application of for pre-applied waterproofing systems is in premium watertight concrete structures. As these additional waterproofing measures must be installed in advance of other construction tasks, they must be professionally planned and executed to prevent water seepage at defective points and unplanned surface cracks in the watertight concrete construction. This ensures that the structures remain dry and reduces subsequent repairs that would otherwise be necessary, usually by injection, to a minimum.

Technology and results

Operating principle

Pre-applied waterproofing systems consist of a sealing layer and a composite layer that are firmly bonded together. They also include other components such as adhesive tapes, liquid plastics, epoxy resin mortar etc. that are all required to turn it into a functioning surface waterproofing system. Further essential components include solutions for membrane joints, penetrations and corners.

A sealing layer can consist of a synthetic material or bitumen that is both resistant to water under pressure and elastic. There are various ways to bond the fresh concrete with the composite layer. The following variants are possible: adhesive bond, mechanical bond, adhesive-mechanical bond or bitumen bond.

The aim of all systems is to achieve a permanent anti-tracking bond in combination with a watertight concrete construction. To this end, it is essential to avoid bonding defects in the layer between the pre-applied waterproof membrane and the concrete. If dirt, rainwater, damage or other influences that could impair the bond are present, these must be removed or repaired before pouring the concrete. The consistency of the concrete and the compaction force can also influence the quality of the bond depending on the system used.

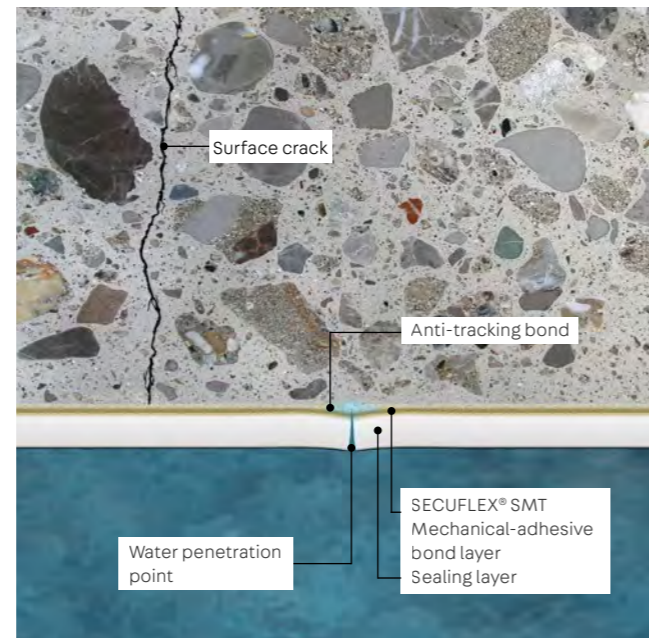

System structure

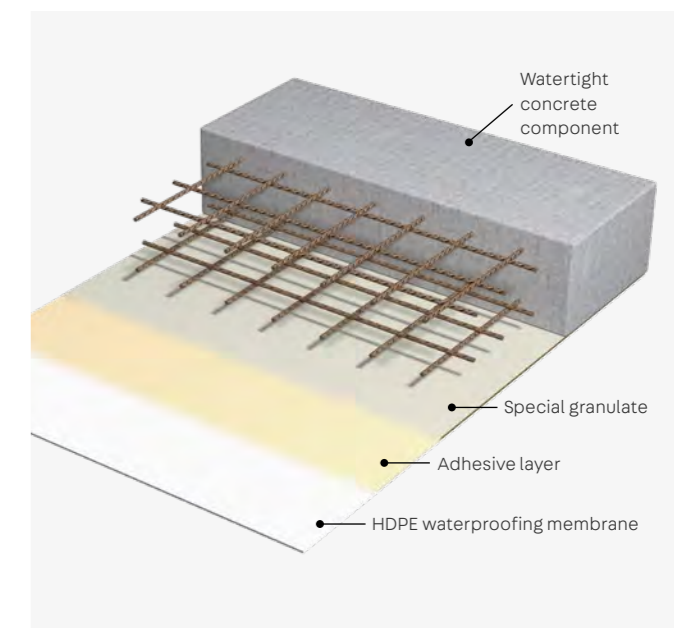

The product

SECUFLEX® has a three-layered structure. The pre-applied waterproofing system consists of an HDPE waterproofing membrane as a sealing layer, a full-surface adhesive layer and a special granulate on top. The integrated adhesive area along one edge is used to connect adjacent membranes directly. The system includes a range of sealing tapes, which are used to join panels and corners depending on the details of the structure.

The granulate performs two tasks simultaneously. Firstly, it protects the membrane layer from contamination and, secondly, it increases both the surface area and the roughness of the surface. The resulting interlock with the cement paste additionally strengthens the bond with the adhesive layer activated by hydration reaction heat and concrete pressure. The resulting mechanical-adhesive bond to the concrete structure in the contact zone of SECUFLEX® guarantees the basic properties of the product, namely a high-strength bond with the structure and the reliable exclusion of water tracking even in areas with very high water exposure. Damage to the waterproofing membrane and contamination of the granulate surface must be excluded or rectified before pouring the concrete for SECUFLEX® to function properly. The surface is usually cleaned by sweeping or vacuuming off any dry and loose dirt and removing any damp or adhering dirt with the aid of a gentle water jet. Cleaning water and rainwater must be removed before pouring the concrete.

The well-known joint sealants PENTAFLEX®, KUNEX® and PLURAFLEX® secure construction joints, crack control joints and expansion joints in the watertight concrete construction in the usual way. Applying an additional layer of SECUFLEX® to their outer surfaces creates a reliable surface seal that permanently and securely bridges even larger cracks. Thanks to the full-surface bond, it prevents water from penetrating through surface cracks and defects.

System components

- SECUFLEX® SMT – HDPE waterproofing membrane as pre-applied waterproofing membrane with adhesive layer and special granulate
- SECUFLEX® ST – HDPE sealing strip with adhesive layer and without special granulate for subsequently gluing over joints
- SECUFLEX® MT – One-sided self-adhesive sealing tape with laminated HDPE film for connecting butt joints on the positive side
- SECUFLEX® PT – One-sided self-adhesive sealing tape with special granulate for application on the negative side, e.g. for protecting butt joints
- SECUFLEX® DT – Double-sided self-adhesive sealing tape for bonding membrane to membrane as a replacement or supplement for the adhesive strips of the SMT waterproofing membrane.
- System products of a watertight concrete construction
- PENTAFLEX® – The seam sheet system for all construction and controlled crack joints
- KUNEX® – The tried-and-tested joint tape for all expansion and construction joints
- PLURAFLEX® – The versatile injection hose for all common injection materials

SECUFLEX®

Pre-applied waterproofing system (FBVS)

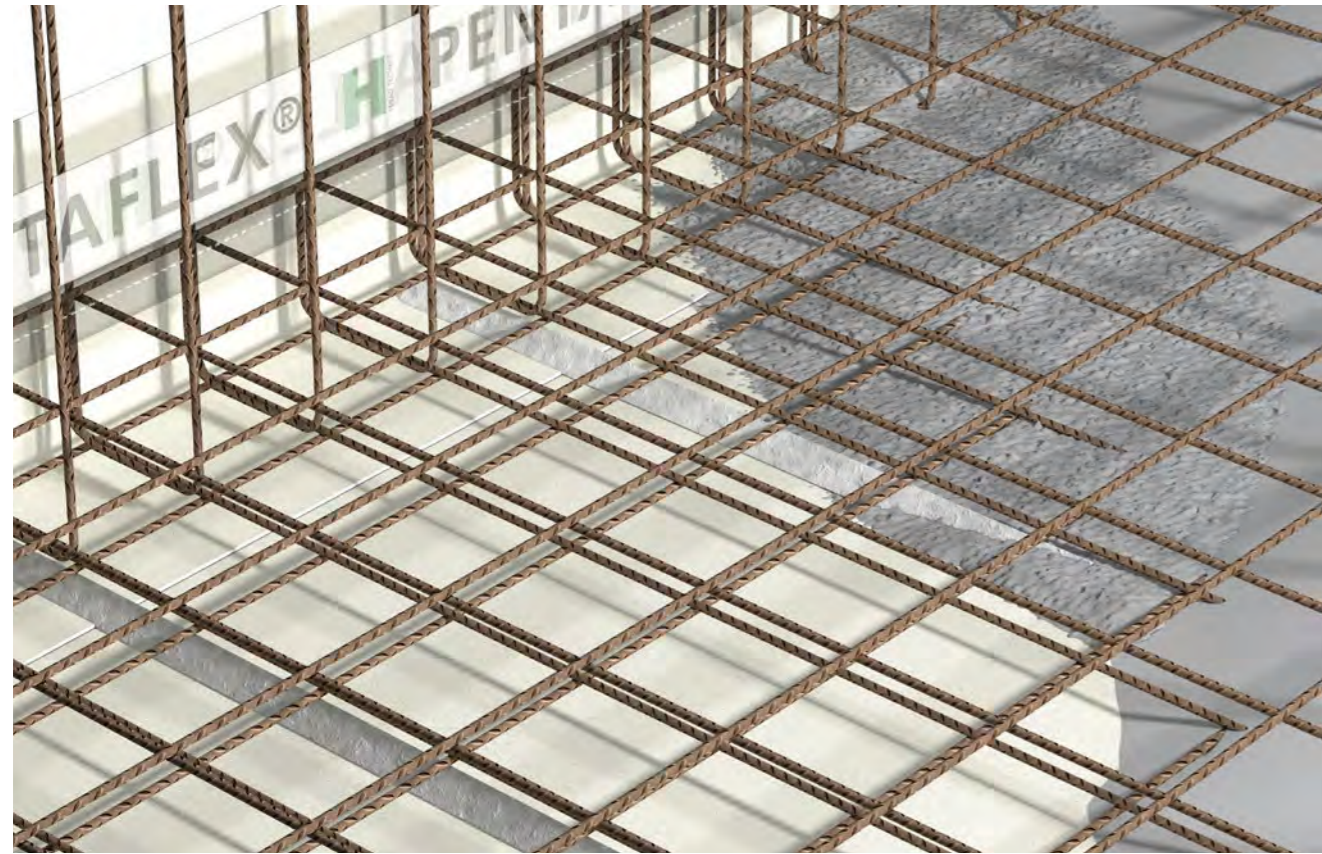

The product

SECUFLEX® pre-applied waterproofing system is a full-surface sealing system consisting of HDPE waterproofing membranes and various waterproofing tapes. It is used in combination with a waterstop system (e.g. PENTAFLEX®) in watertight concrete constructions to keep out water under pressure. An adhesive layer combined with a special granulate creates an anti-tracking bond between the waterproofing layer and the concrete so that any cracks that occur in the watertight concrete construction are reliably bridged and remain permanently dry.

Area of application

SECUFLEX® FBVS is mainly used in high-grade buildings, such as libraries, schools, shopping centres and hospitals. It must be installed with a watertight concrete construction and must also be contractually agreed upon with the builder.



Benefits

- Excellent material properties
- Mechanical and adhesive anti-tracking bond
- Bridges cracks
- Consistency class from F3
- Bond unaffected by compaction
- Integrated longitudinal adhesive strips

Technical information



SECUFLEX® SMT 1212

HDPE waterproofing membrane as pre-applied waterproofing membrane with adhesive layer and special granulate.

Dimensions:

- L = 20 m
- W = 1200 mm
- Th = 1.2 mm



SECUFLEX® ST 600

HDPE sealing strip with adhesive layer and without special granulate for subsequently gluing over joints.

Dimensions:

- L = 20 m
- W = 600 mm
- Th = 1.2 mm



SECUFLEX® MT 150

One-sided self-adhesive sealing tape with laminated HDPE film for connecting butt joints on the positive side.

Dimensions:

- L = 50 m
- W = 150 mm
- Th = 0.3 mm



SECUFLEX® PT 150

One-sided self-adhesive sealing tape with special granulate for application on the negative side, e.g. for protecting butt joints.

Dimensions:

- L = 20 m
- W = 150 mm
- Th = 1.0 mm



SECUFLEX® DT 75

Double-sided self-adhesive sealing tape for bonding membrane to membrane as a replacement or supplement for the adhesive strips of the SMT waterproofing membrane.

Dimensions:

- L = 30 m
- W = 75 mm
- Th = 1.0 mm

Material parameters

Properties in line with DIN EN 13967	Test standard	Test result
Visible defects	DIN EN 1850-2	Passed
Dimensions and deviations	DIN EN 1848-2	Length: 20 m ± 0.10 m Width: 1200 mm ± 5 mm Straightness: Passed
Thickness and area density	DIN EN 1849-2	Membrane thickness: 0.9 mm (+10/-5%) Area density: 1550 g/m² ± 10%
Water tightness	DIN EN 1928-A Water pressure 60 kPa (0.6 bar)	Passed
Water tightness	DIN EN 1928-B Water pressure 400 kPa (4.0 bar)	Passed
Resistance to impact	DIN EN 12691-A Substrate: Al panel	400 mm drop height
Resistance to impact	DIN EN 12691-B Substrate: EPS panel	800 mm drop height
Resistance to thermal ageing	DIN EN 1296 and DIN EN 1928-A	Passed
Resistance to chemicals	DIN EN 1847 and DIN EN 1928-A	Passed
Compatibility with bitumen	DIN EN 1548 and DIN EN 1928-A	Passed
Resistance to tearing (nail shank)	DIN EN 12310-1	Lengthways ≥ 500 N Across ≥ 650 N
Shear resistance of joints	DIN EN 12317-2	≥ 650 N / 50 mm
Water vapour permeability	DIN EN 1931-B	g: 6.97*10 ⁻¹⁰ kg/(m²*s) ± 30%
Resistance to static loads	DIN EN 12730-A Substrate: EPS panel	Imposed load ≤ 15 kg
Resistance to static loads	DIN EN 12730-B Substrate: concrete	Imposed load ≤ 20 kg
Resistance to static loads	DIN EN 12730-C Substrate: EPS panel	Imposed load ≤ 15 kg
Tensile properties (maximum tensile strength)	DIN EN 12311-2	Lengthways ≥ 120 N / 6 mm Across ≥ 140 N / 6 mm
Tensile properties (tear strength)	DIN EN 12311-2	Lengthways ≥ 13 N / mm² Across ≥ 14 N / mm²
Tensile properties (elongation at break)	DIN EN 12311-2	Lengthways ≥ 500 N Across ≥ 650 N
Reaction to fire	DIN EN ISO 11925-2 and EN 13501-1	Class E

Installation instructions

Preliminary notes

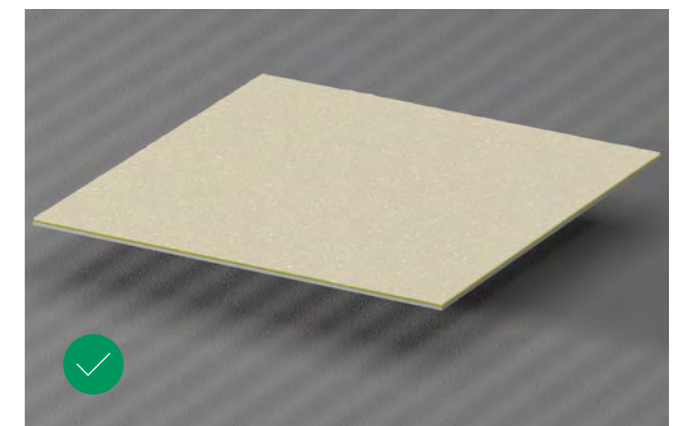
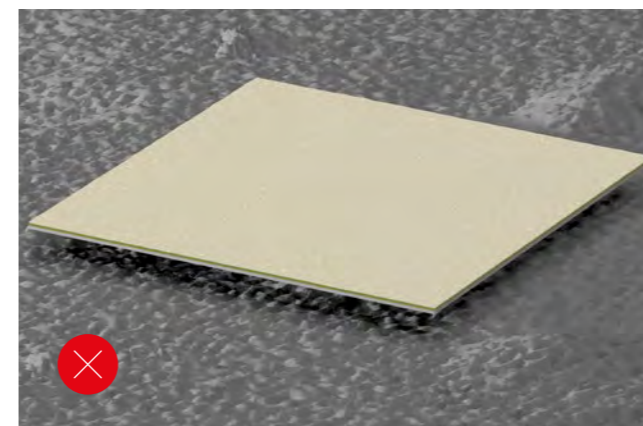
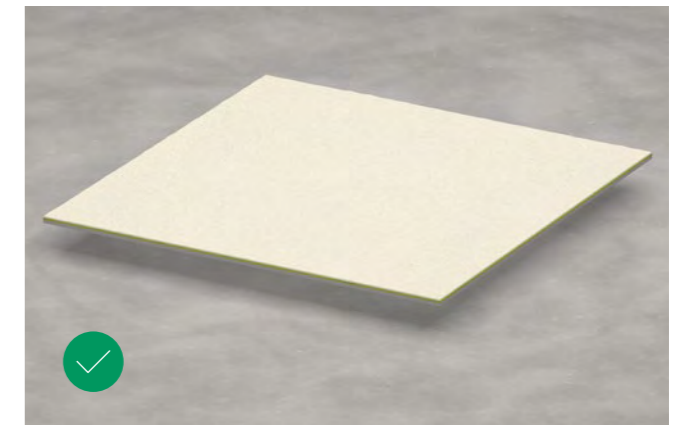
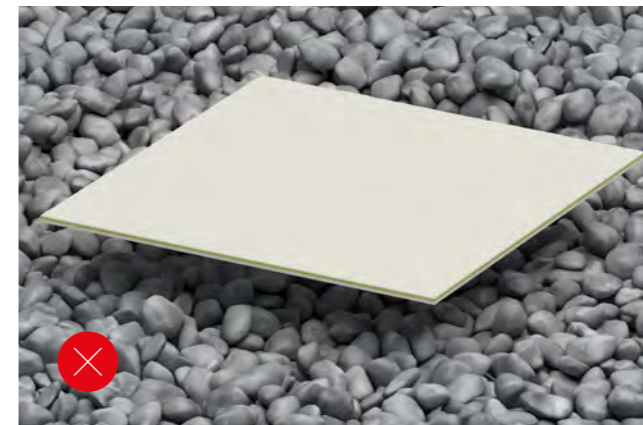
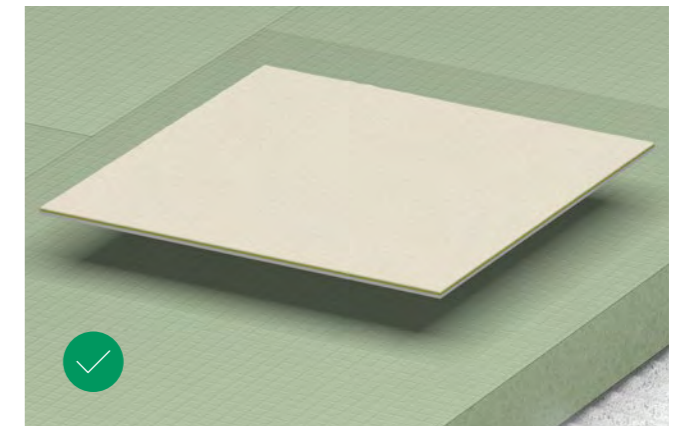

Preliminary notes

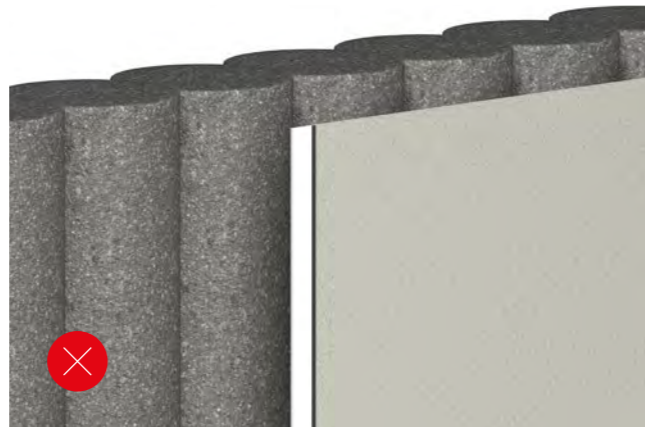
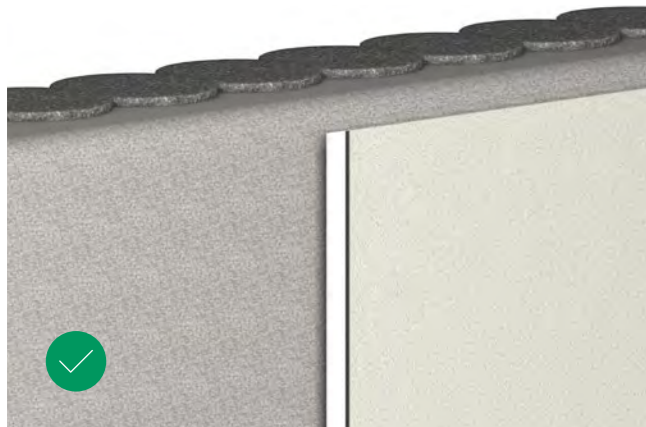
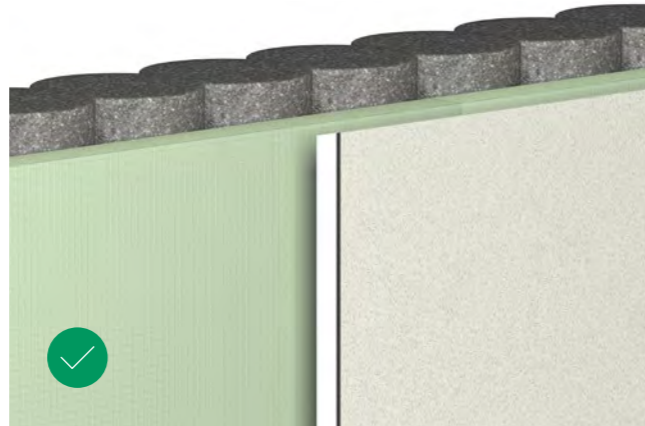
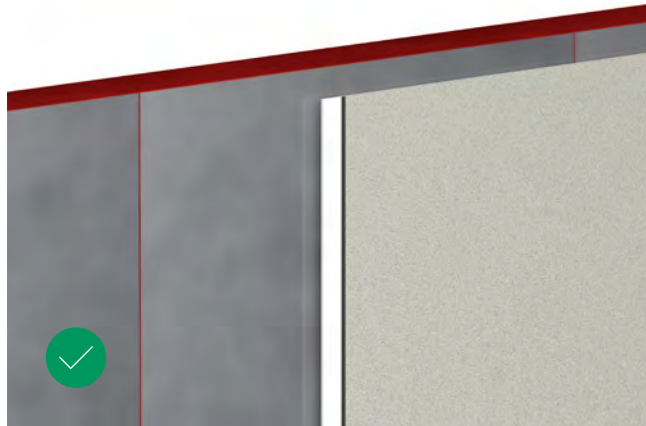
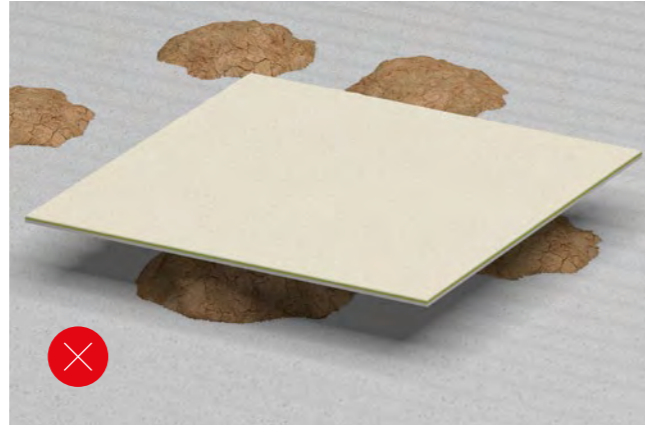
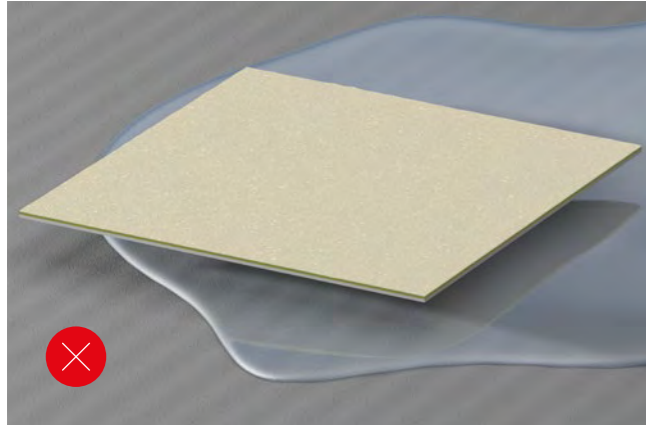

Floor

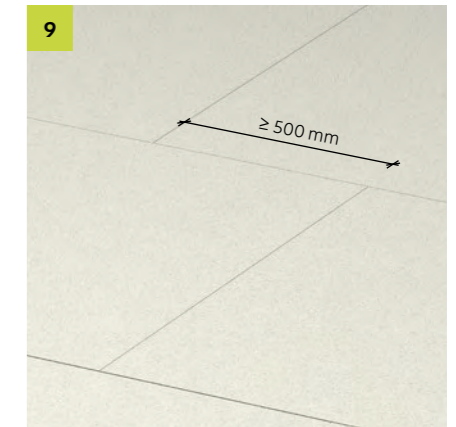
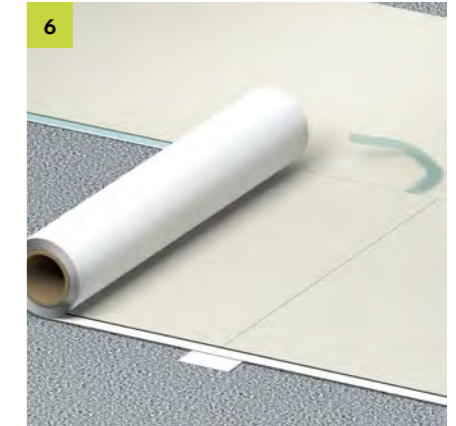
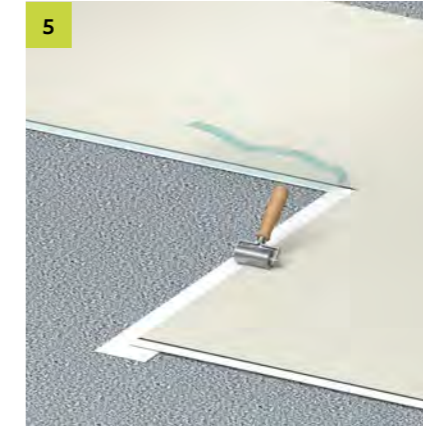
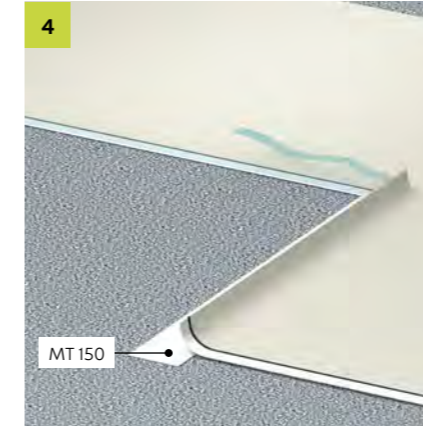
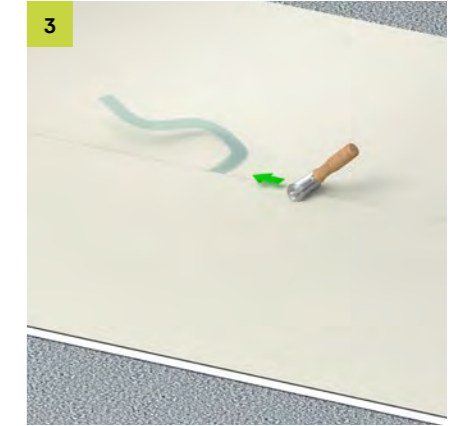
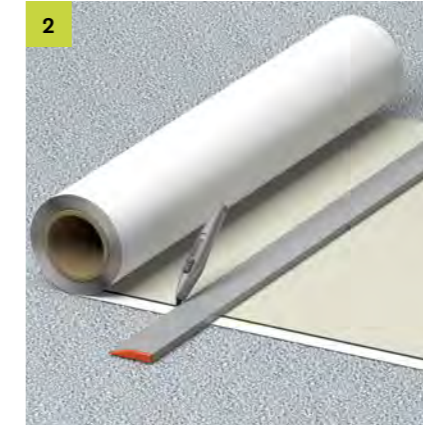
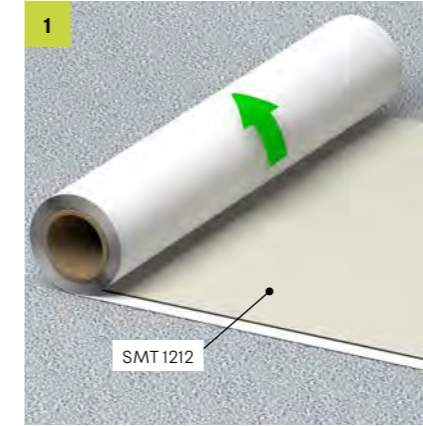

Floor

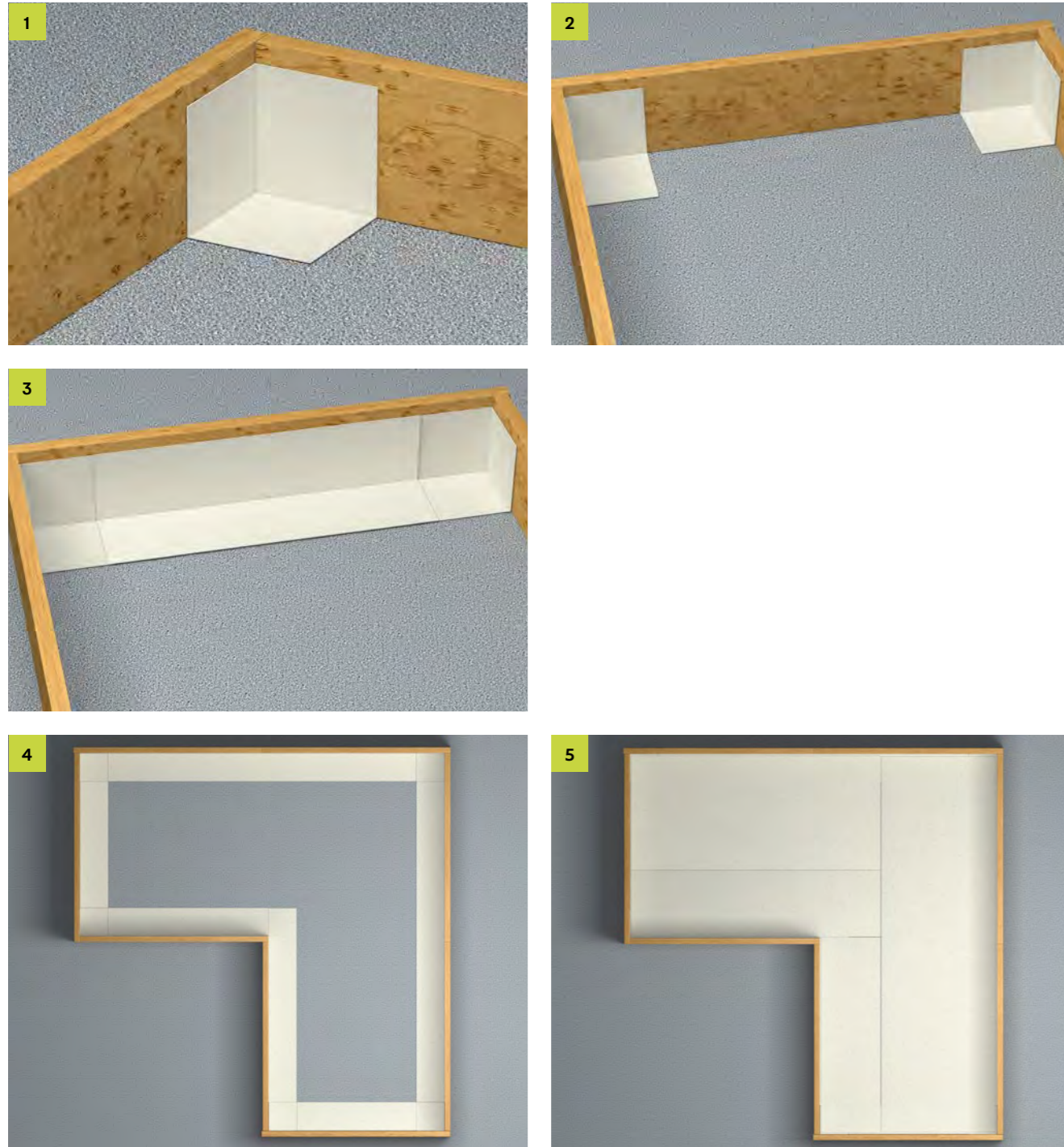

Floor

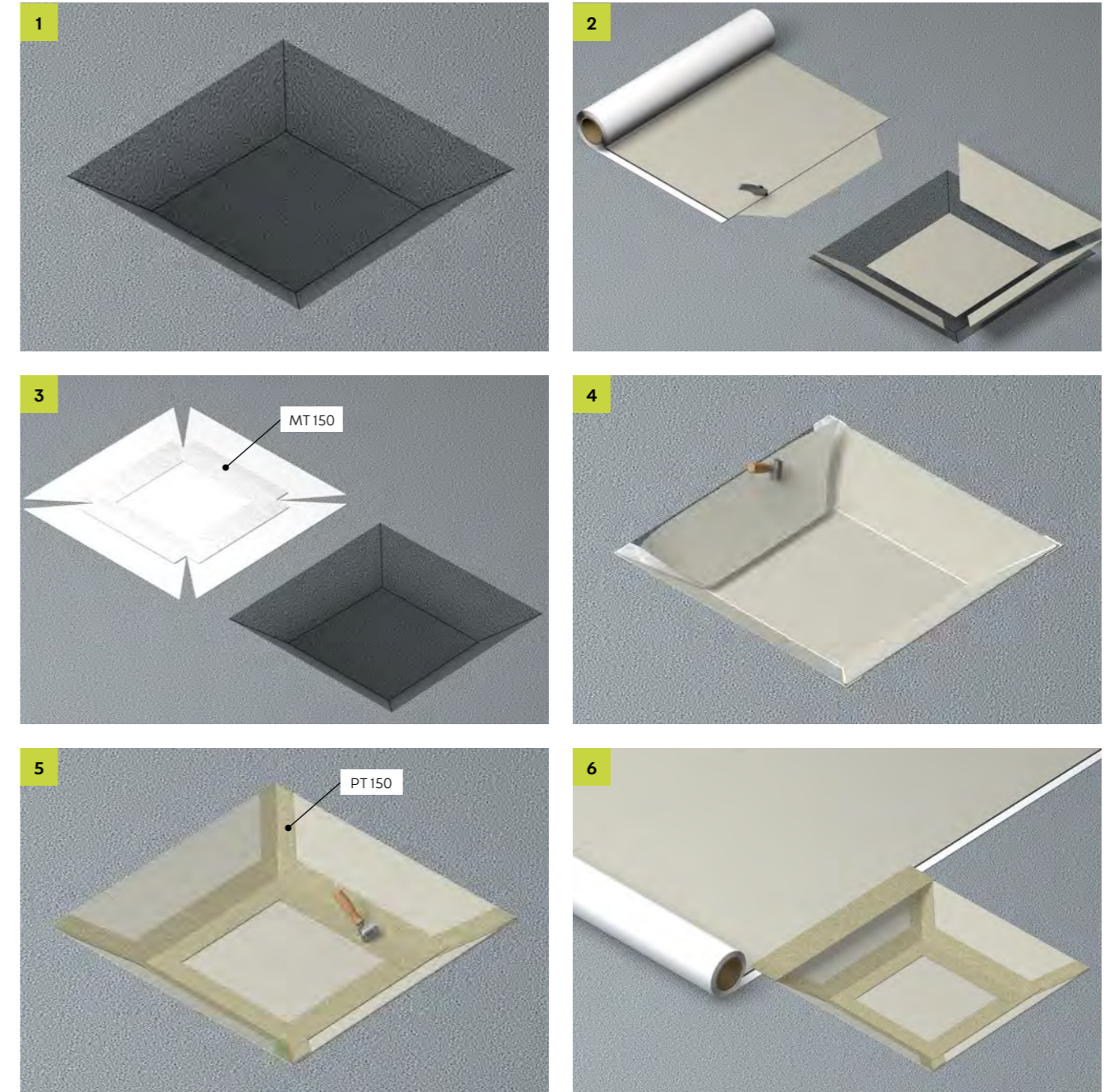

Consultation

Our Application Technology department will be happy to assist you with further solutions:

Phone: +49 7742 9215-300
Fax: +49 7742 9215-319
Email: technik@h-bau.de

Inner corner

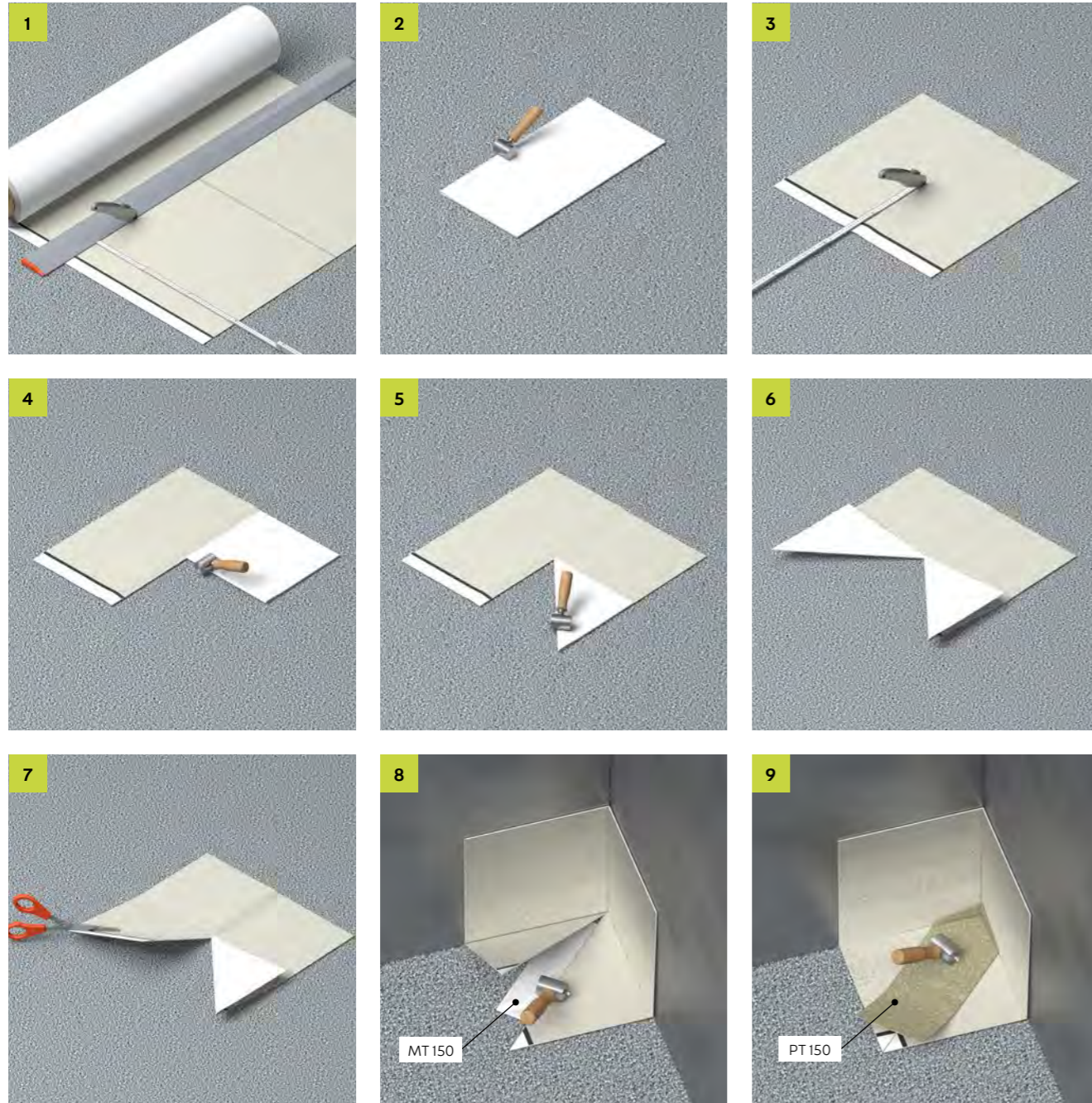

Outer corner

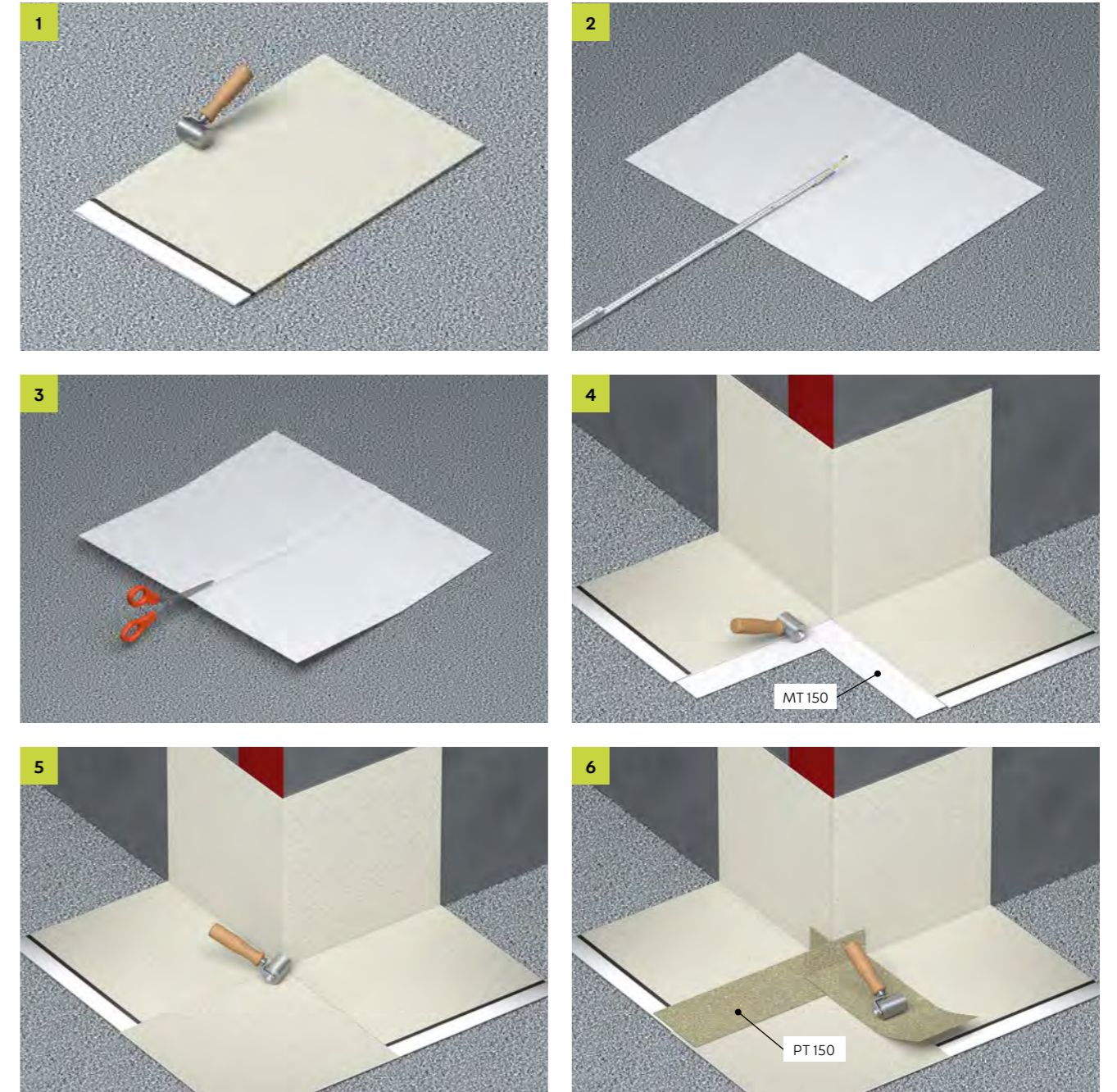

Details (penetrations)

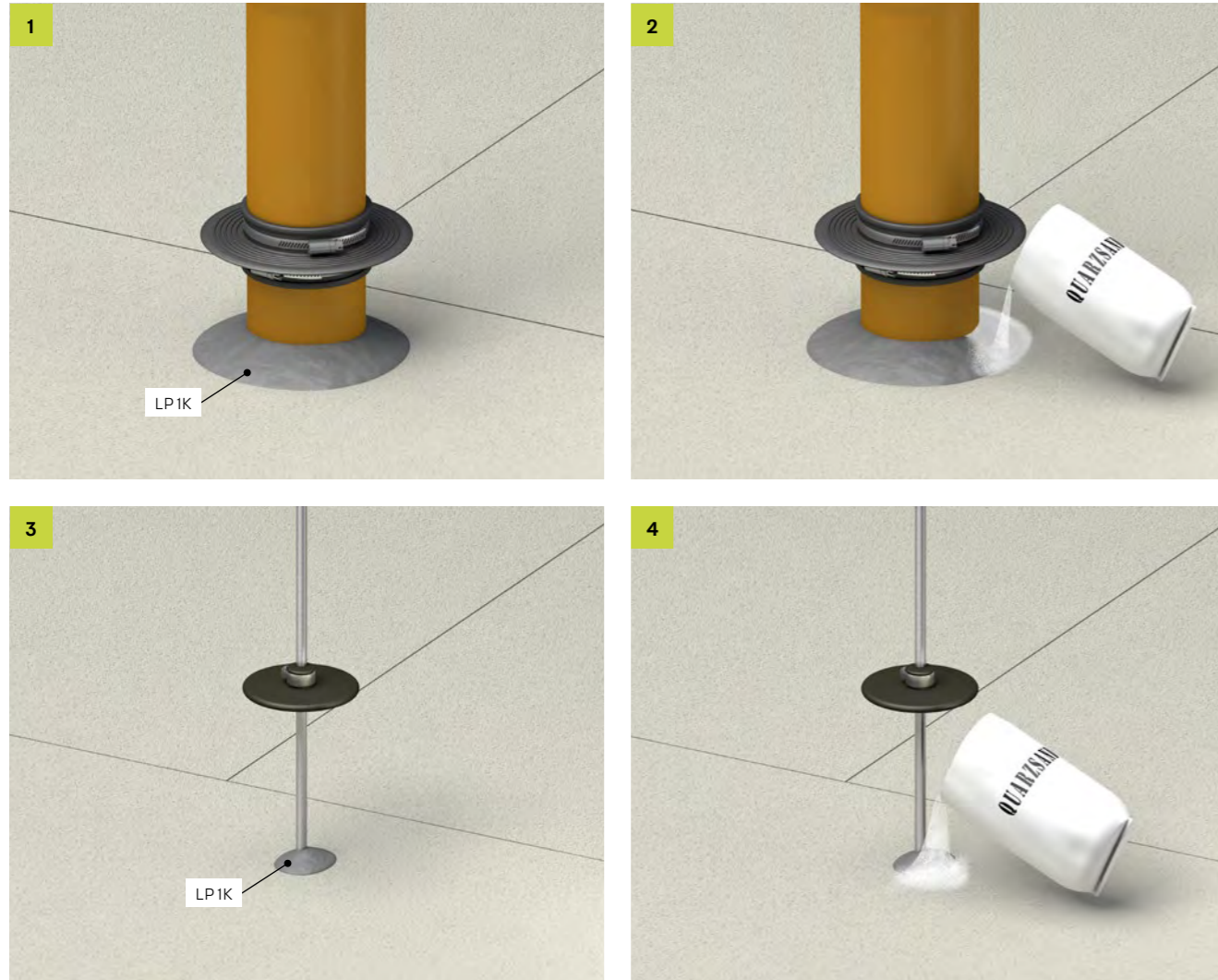

Details (bored pile)

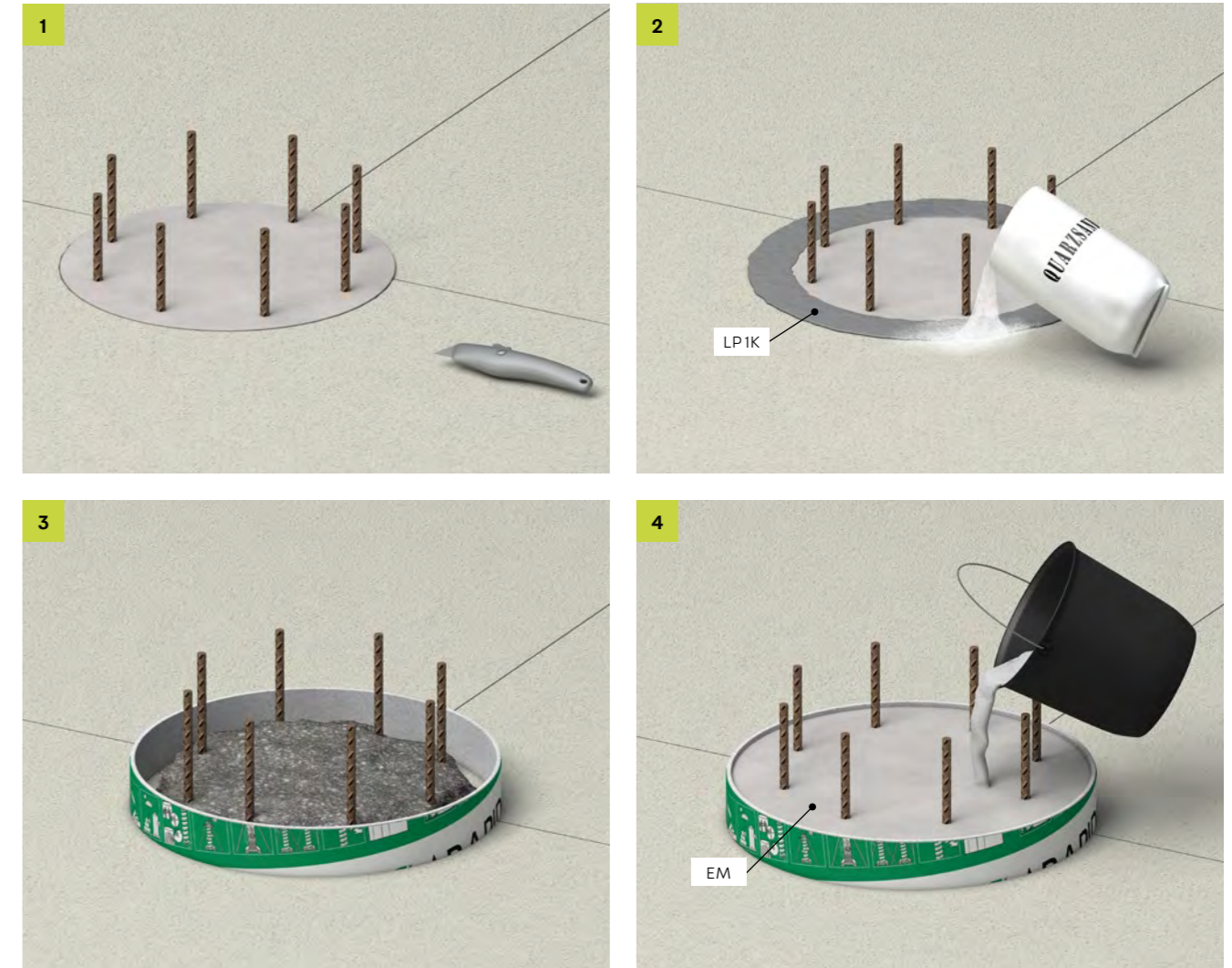

General

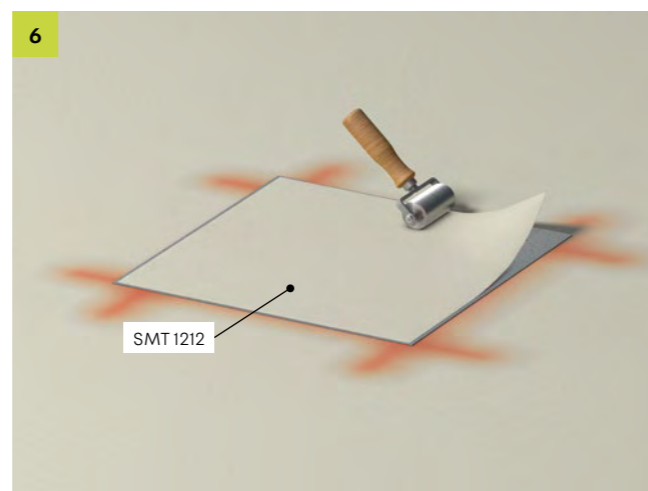
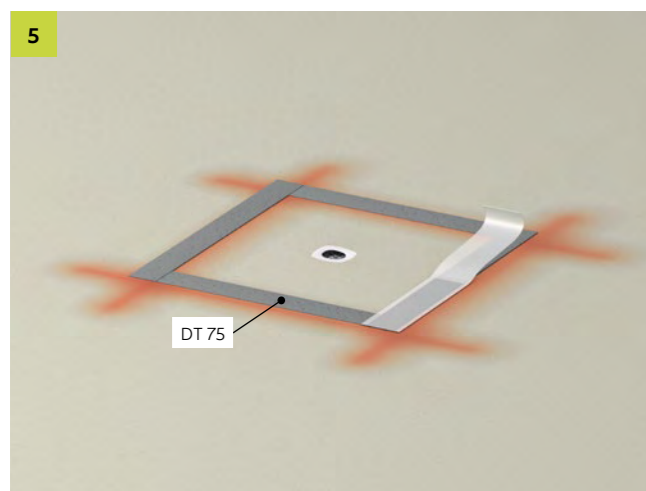
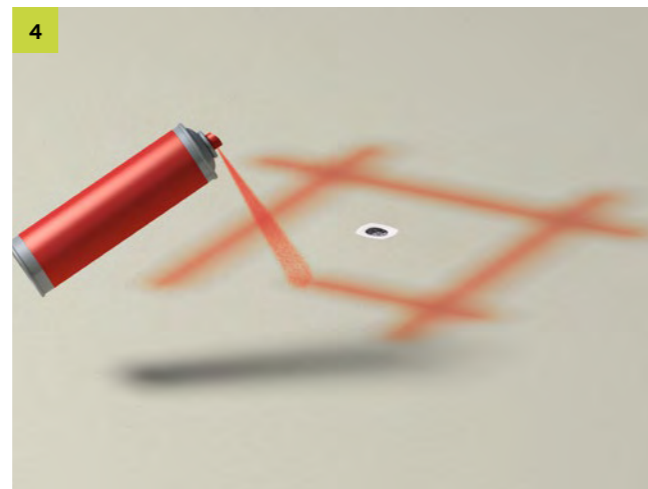
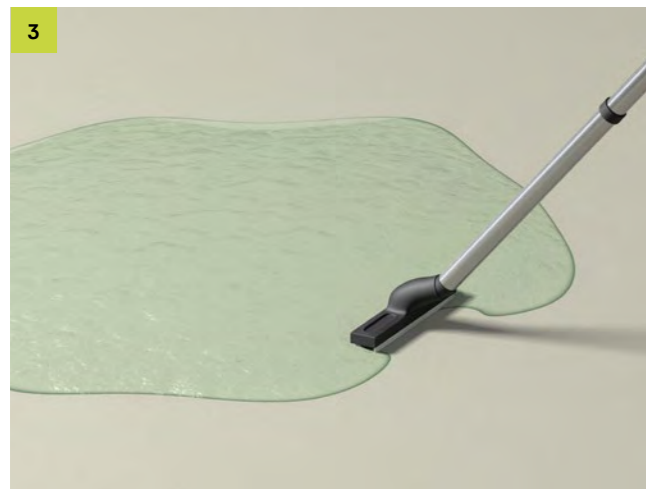
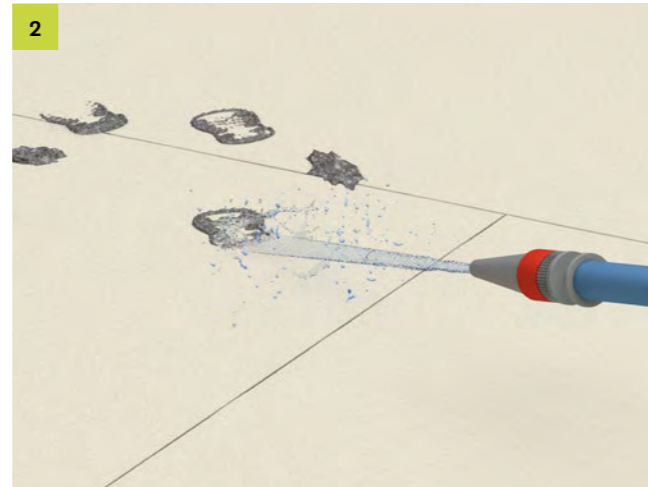

Details

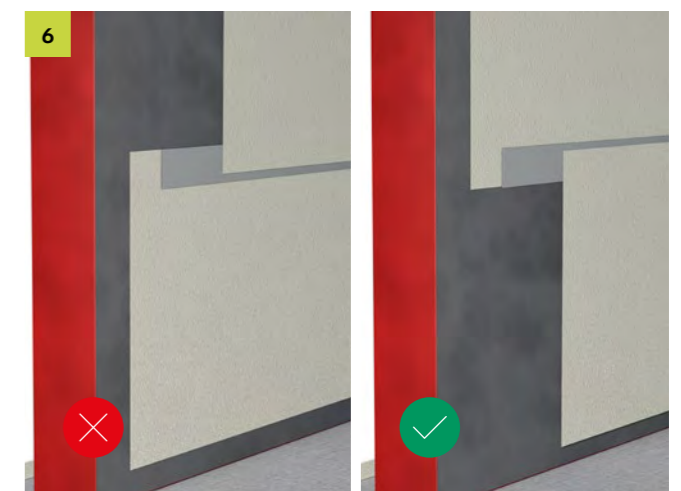
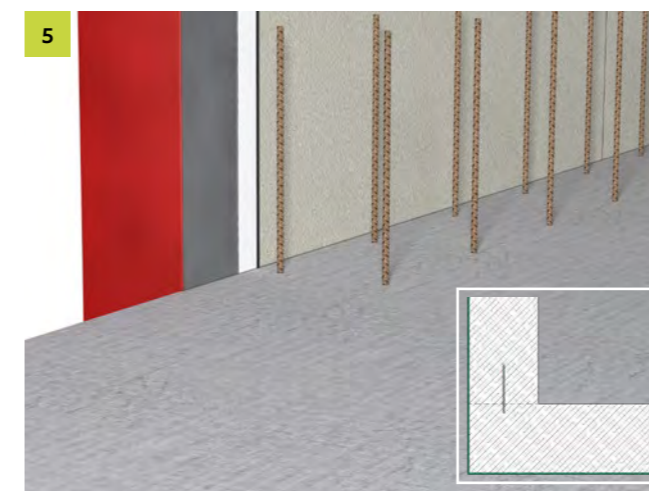
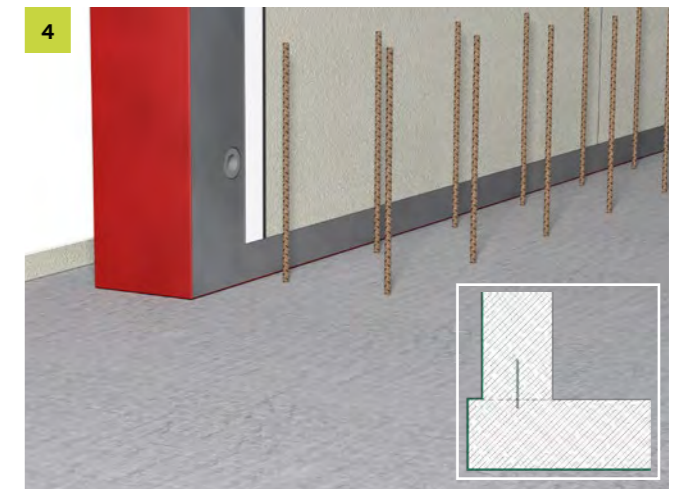
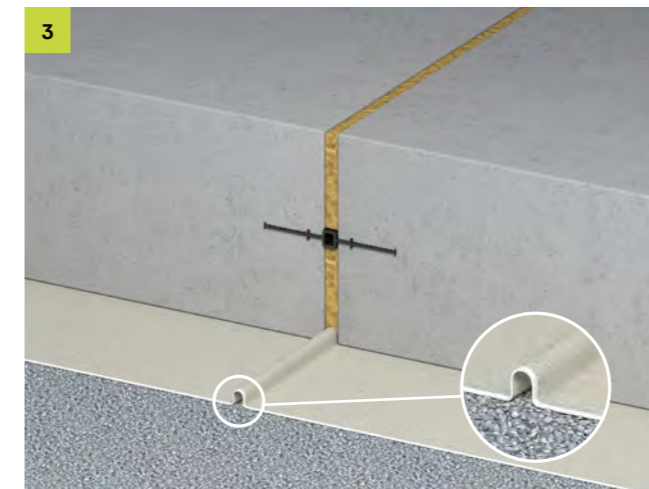
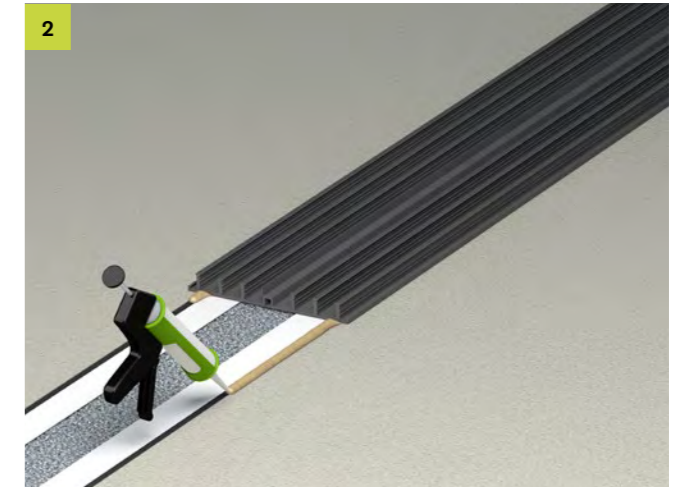
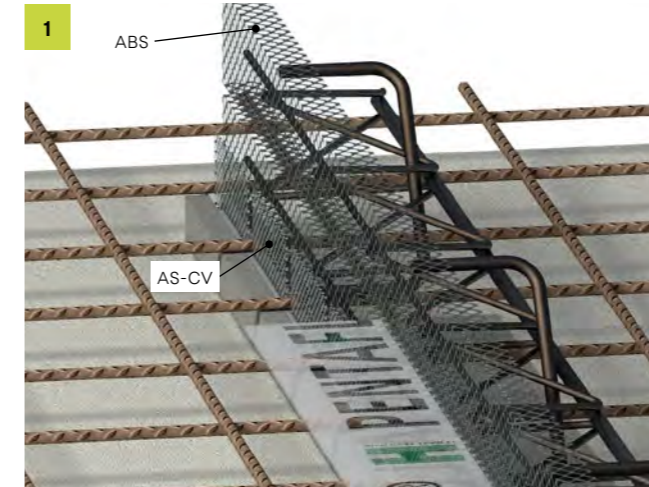

Wall

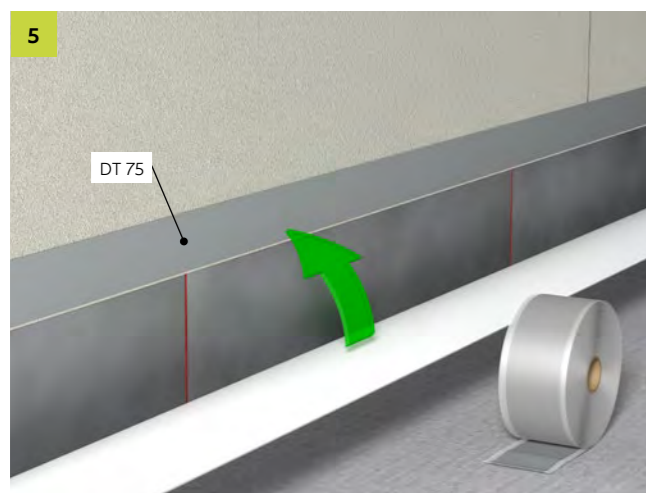
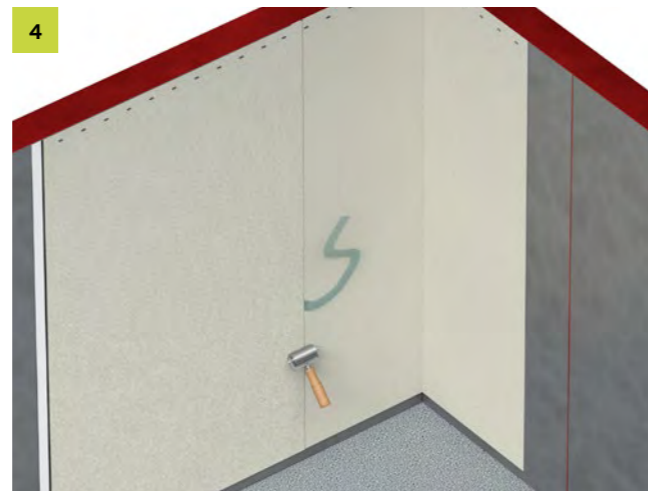
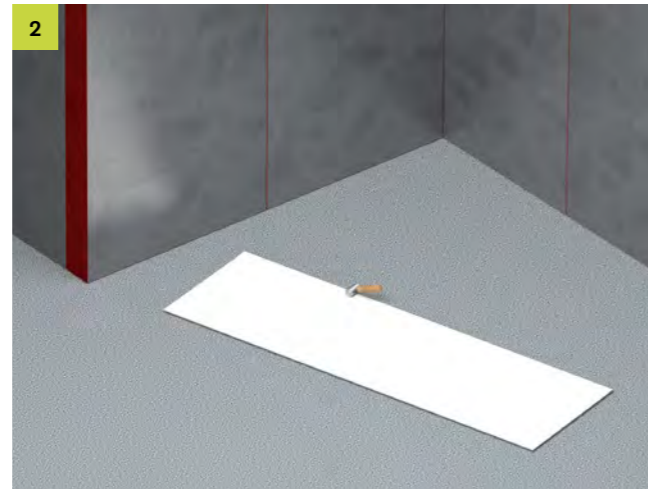
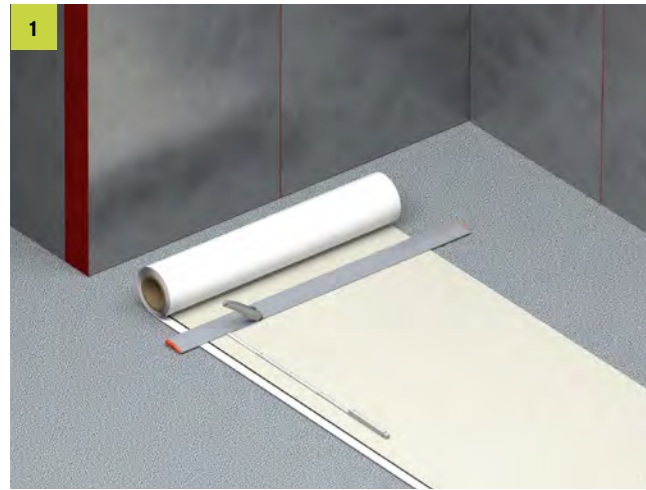

Wall

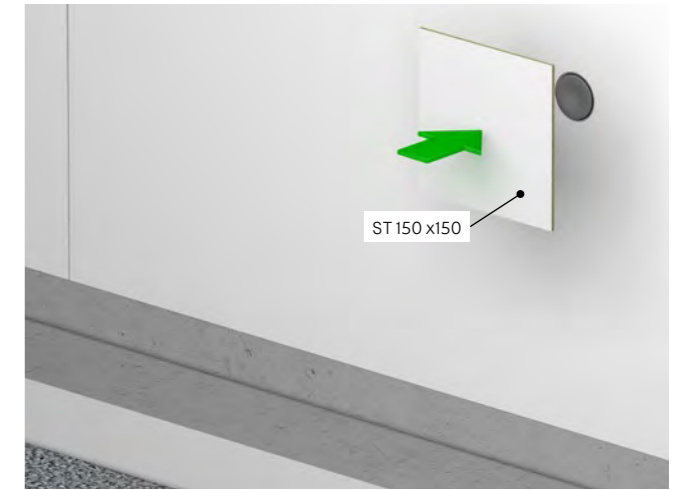
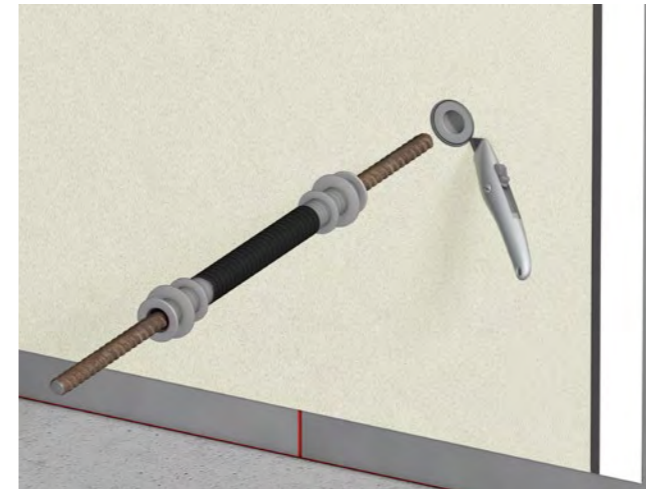

Accessories



PR 50 pressure roller



PR 90 pressure roller



PR 100 L pressure roller



LP1K liquid plastic



Silica sand



EM epoxy resin mortar



Inner corner

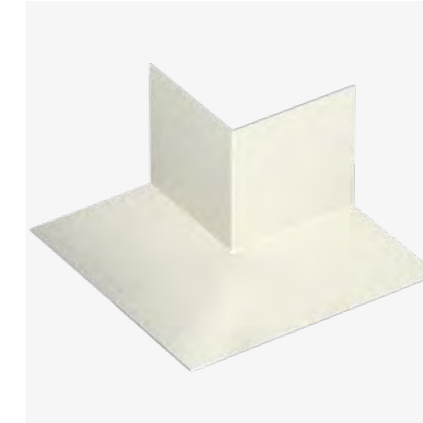

Outer corner



ST 150x150



A-CV shuttering strip

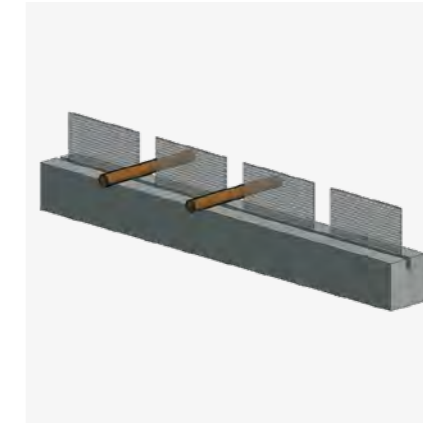

AS-CV shuttering strip

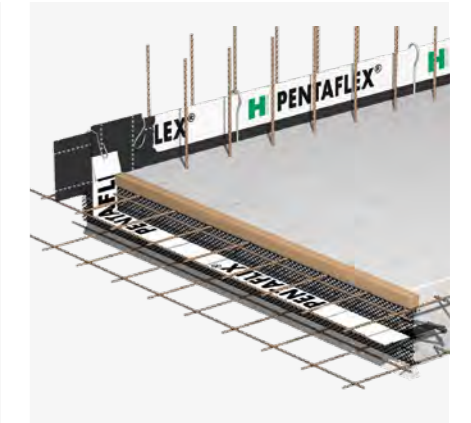

ABS shuttering element

Additional products

In line with the German watertight concrete guideline



Pentaflex® sealing system

PENTAFLEX® is a joint sealing system for creating waterproof concrete structures (white tank). PENTAFLEX® elements are fully coated and were developed for use in high-grade buildings. They reliably seal wall/floor or wall/ceiling joints, wall/wall and floor/floor joints and joints in in-situ concrete constructions and constructions built using prefabricated wall elements.



KUNEX® joint tapes

KUNEX® joint tapes reliably seal construction joints and expansion joints in concrete. KUNEX® joint tapes guarantee an excellent mechanical bond between the concrete components and thereby create a reliable seal. The joint tapes are made from top-quality thermoplastic PVC-P/TPE. Dummy joints are sealed using sealing tubes. Building-specific joint tape constructions are used to form watertight connections in existing structures.



Pluraflex® injection hoses

PLURAFLEX® injection hoses are joint-sealing elements that supplement the PENTAFLEX® sealing system. The injection hoses are used in structural, civil and construction engineering projects where methodical sealing of construction joints is required. They are ideal for tunnel construction and are the best solution for building the first sections that are exposed to water pressure.

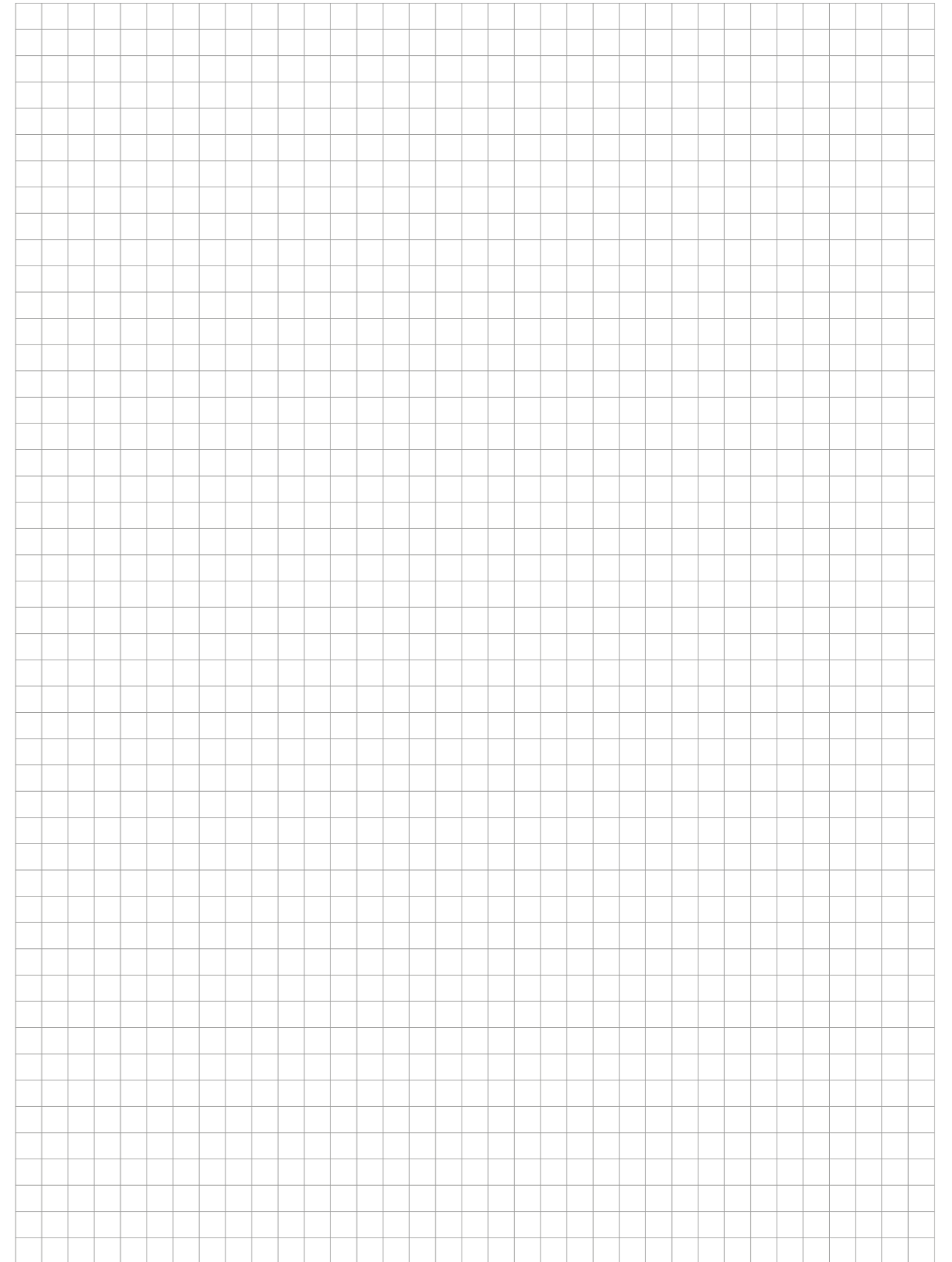

Our synergy concept for your benefit

With us, you benefit from the collective experience of three established manufacturers, who combine products and expertise in a comprehensive range. That is the PohlCon synergy concept.



Full-service consulting

Our extensive network of consultants is available to answer all your questions about our products on site. From planning to use, you can enjoy personal support from our qualified employees.



Digital solutions

Our digital solutions provide targeted support in planning with our products. From tender texts to CAD details and BIM data, right through to modern software solutions, we offer customized support for your planning process.



7 fields of application

We think in terms of holistic solutions. This is why we have combined our products into seven fields of application, where you can benefit from their synergy and the overall PohlCon product portfolio.

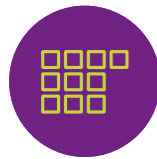

10 product categories

In order to find the right product in our extensive range even faster, we have divided our products into ten product categories. This way you can navigate unerringly between our products.



Individual solutions

No series product on the market is suitable for your project? We realize unique construction projects and exceptional challenges with the many years of expertise of the three manufacturing brands.



Errors and technical changes reserved. Reprinting and any electronic reproduction only authorised with our written permission. All previous documents lose their validity with the publication of this printed matter.

PohlCon GmbH

Nobelstr. 51
12057 Berlin
Germany

T +49 30 68283-04
F +49 30 68283-383

www.pohlcon.com